

Linea Classic

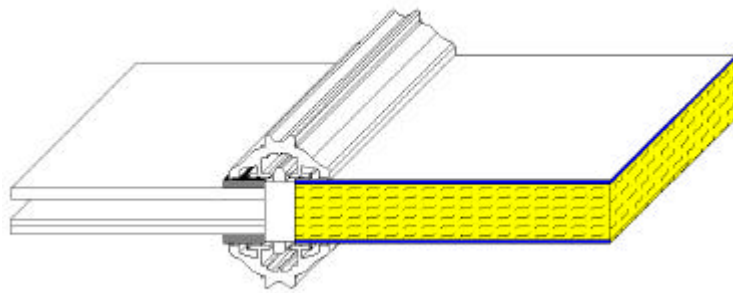

ATENAS

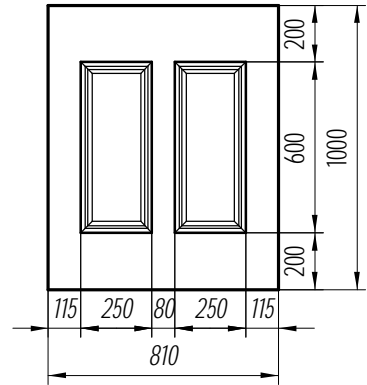
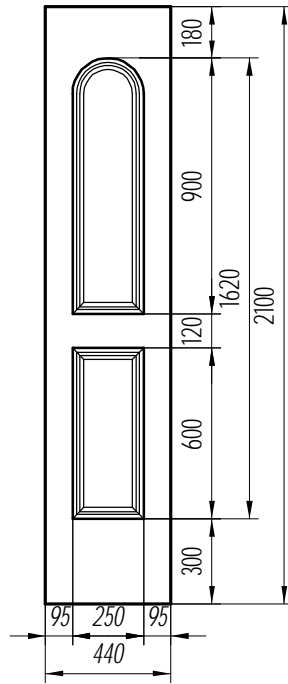
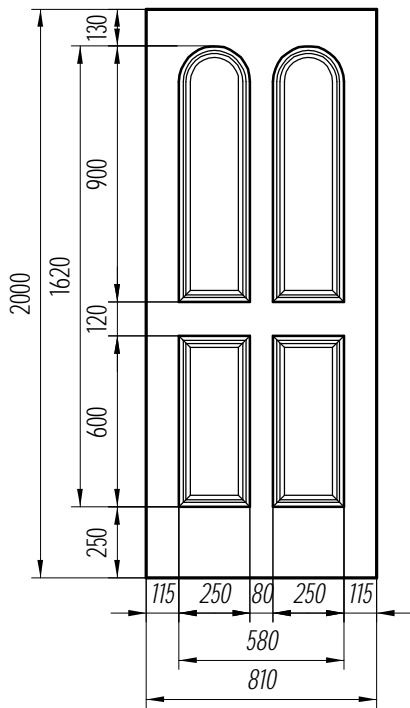

BARCELONA

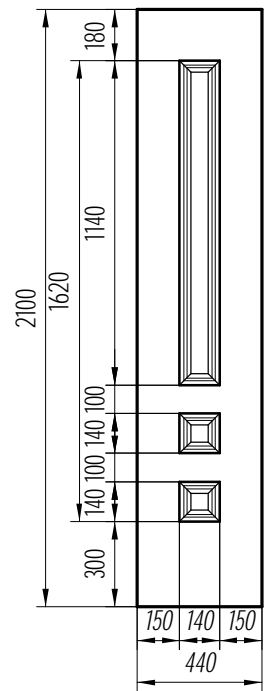
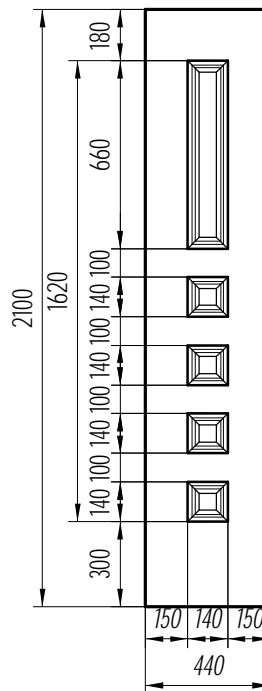
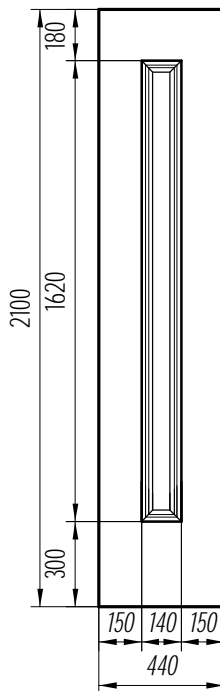
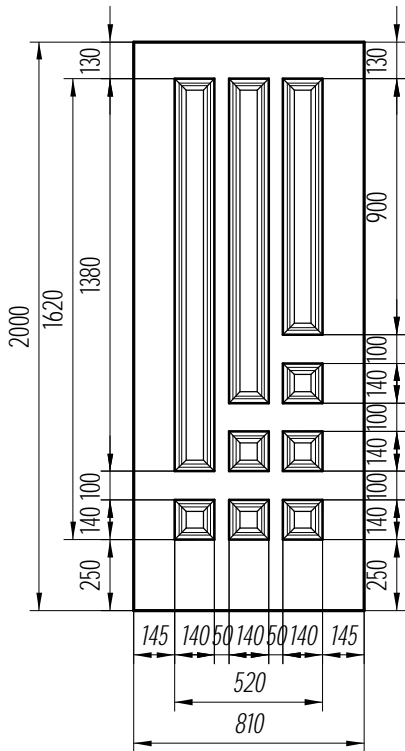

BRUSELAS

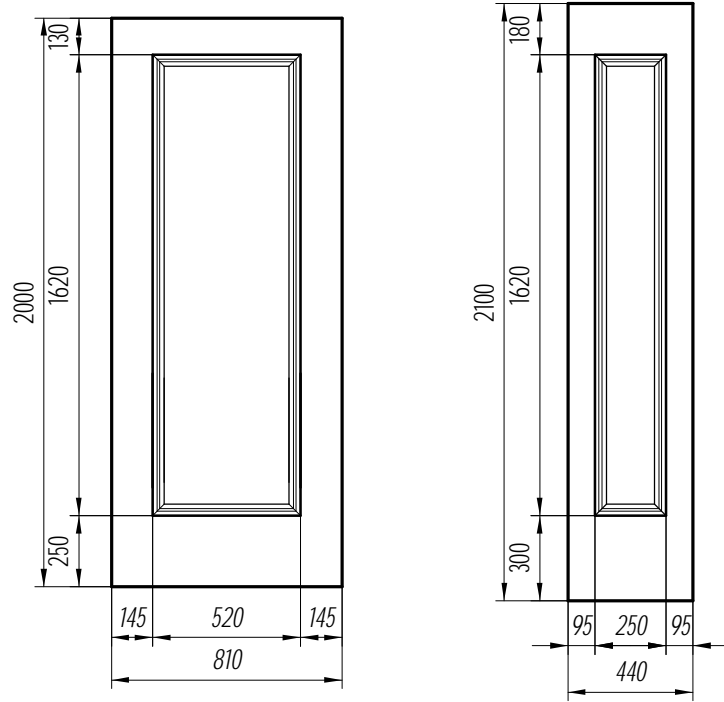

BUENOS AIRES

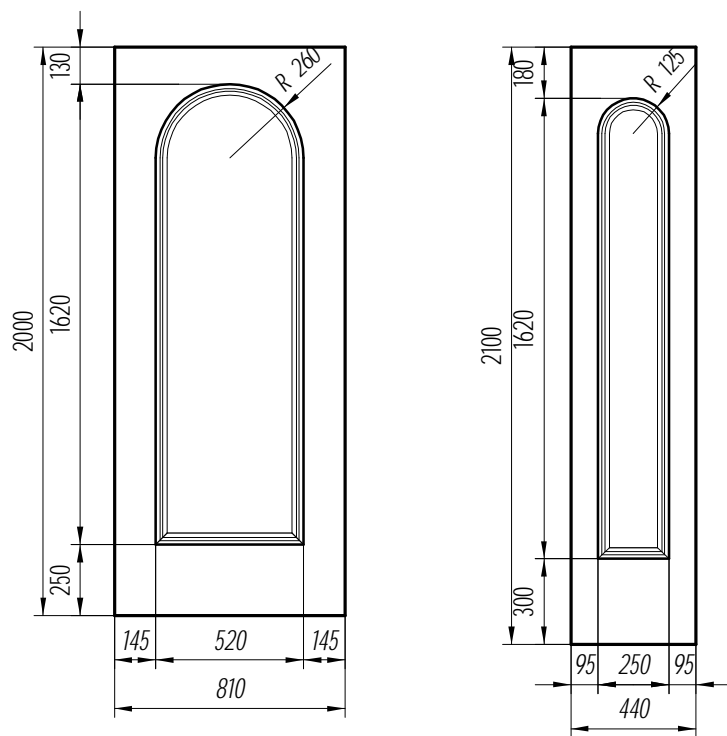

BUENOS AIRES 2000

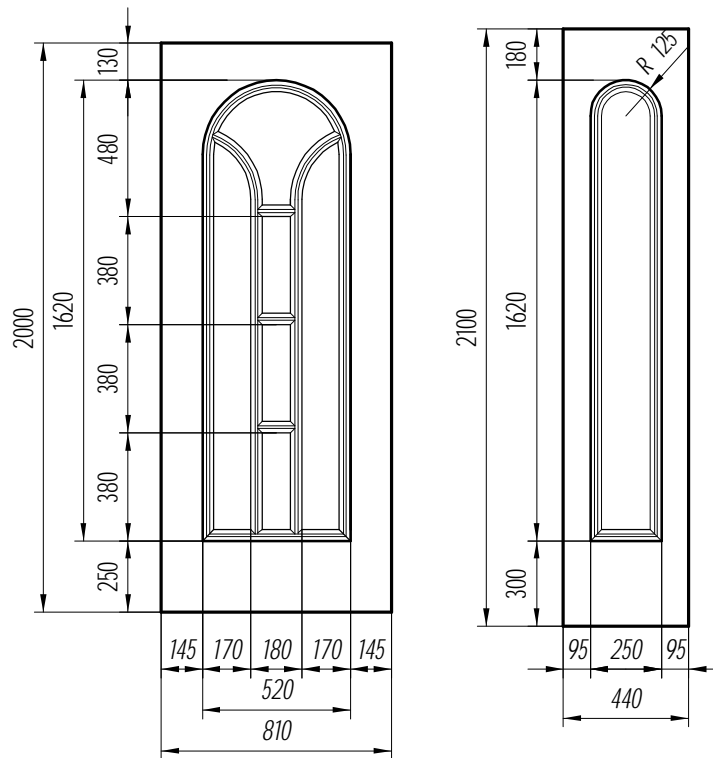

BUENOS AIRES 2001

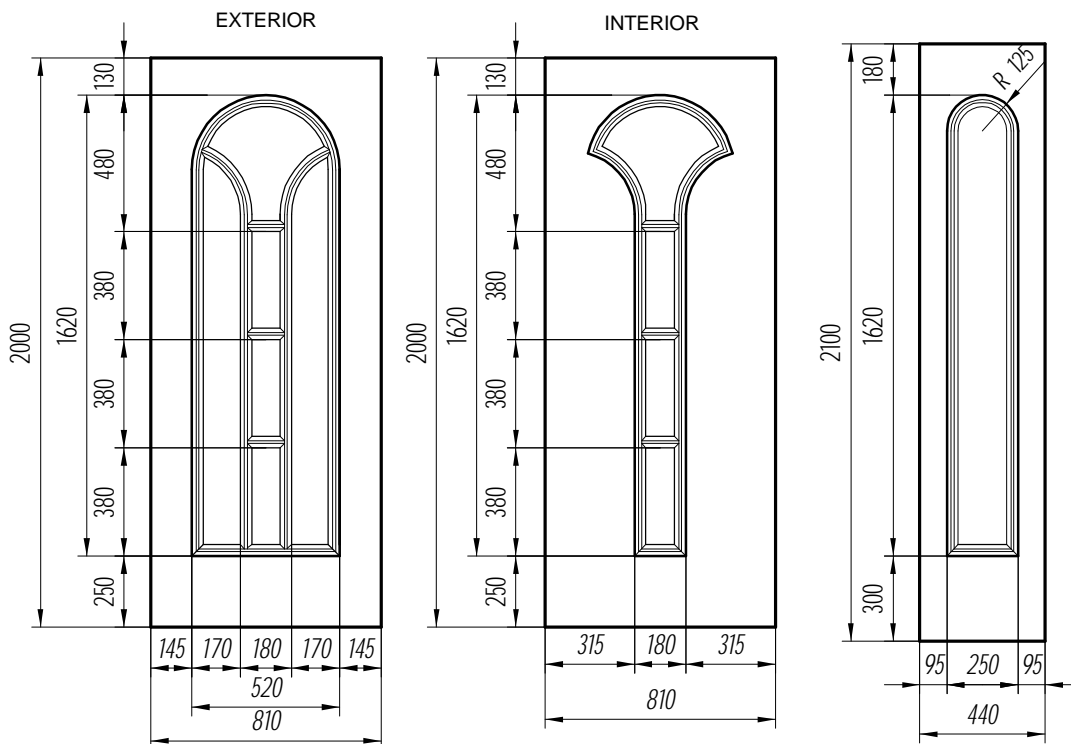

BUENOS AIRES 2002

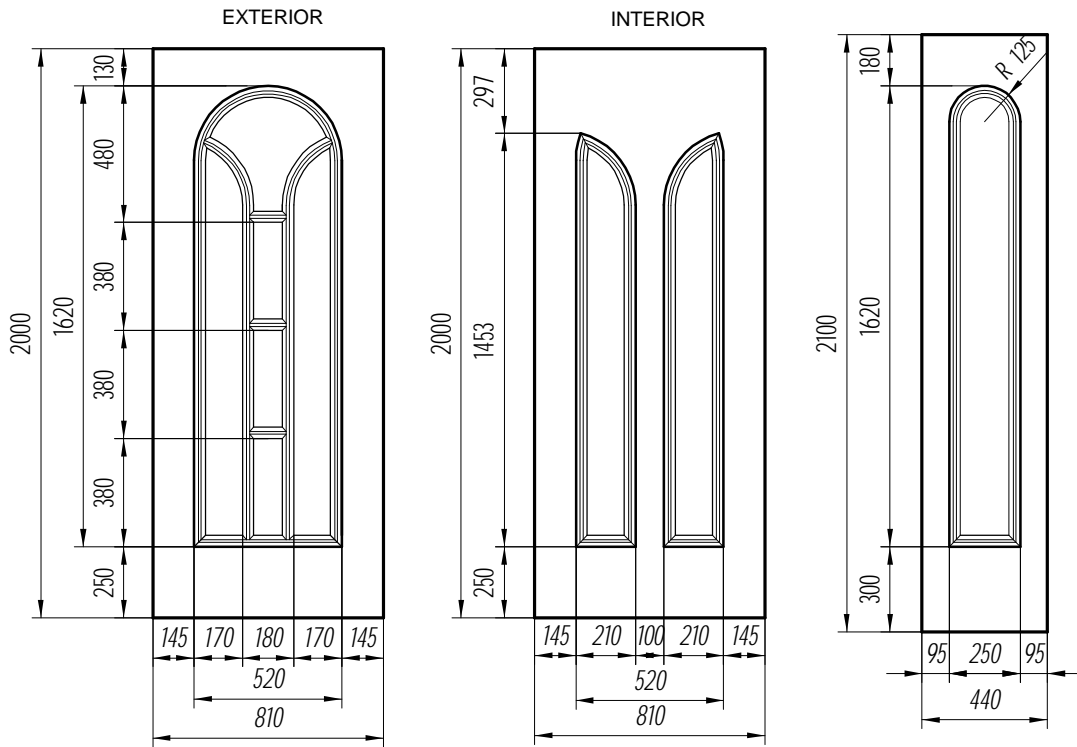

DOREA

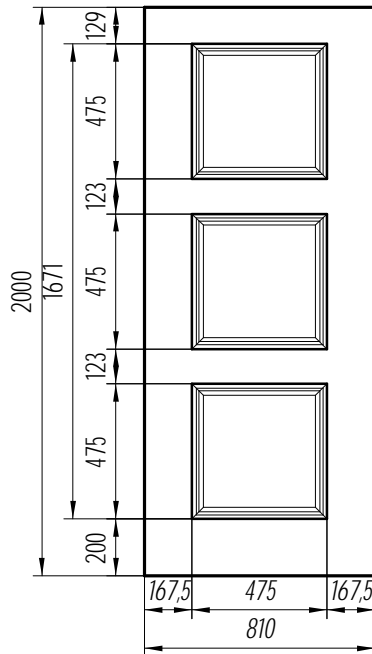

DUBLIN

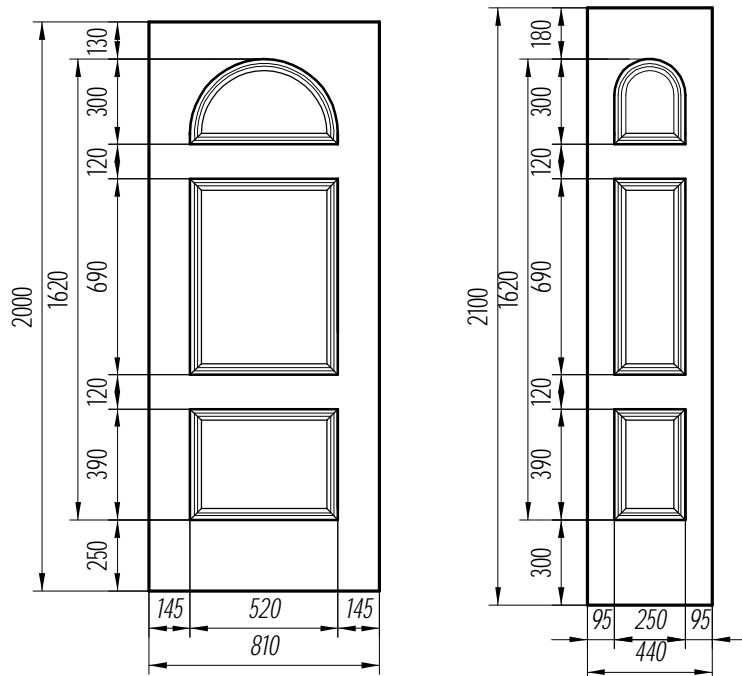

EDIMBURGO

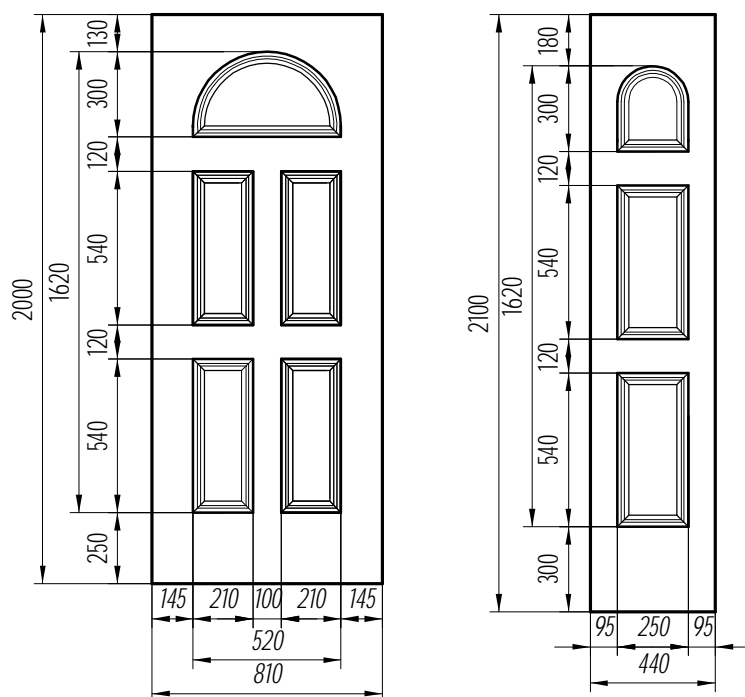

ESTOCOLMO

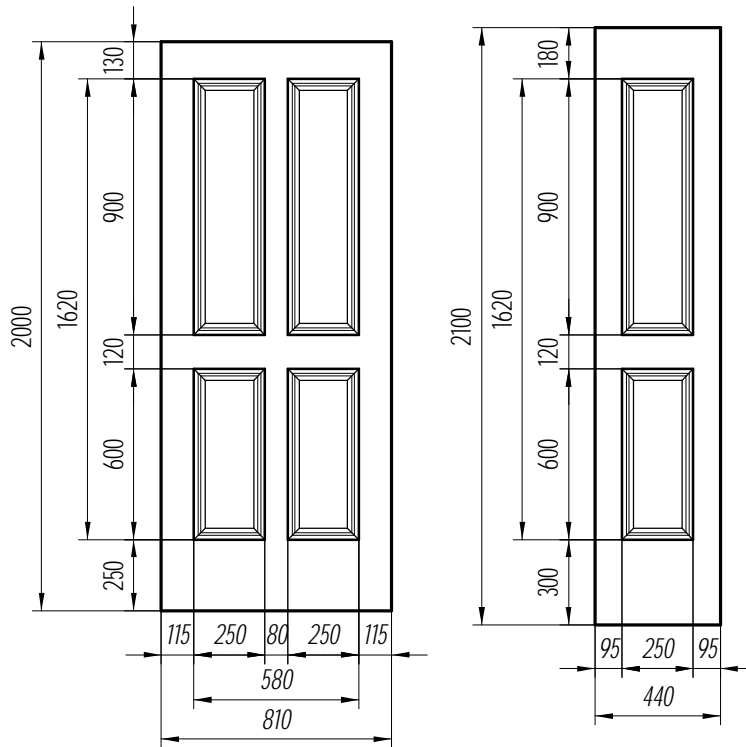

FLAMENCO

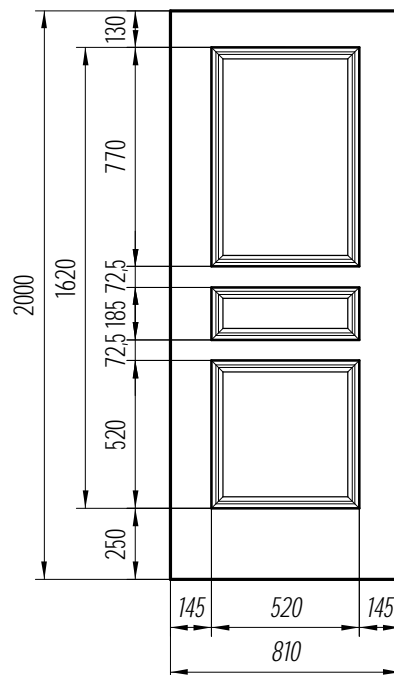

LISBOA

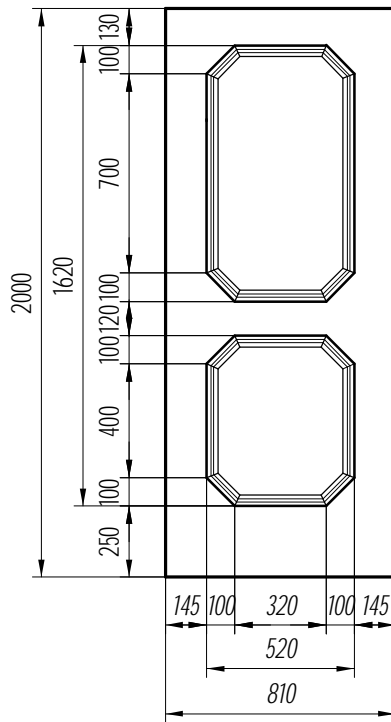

LONDRES

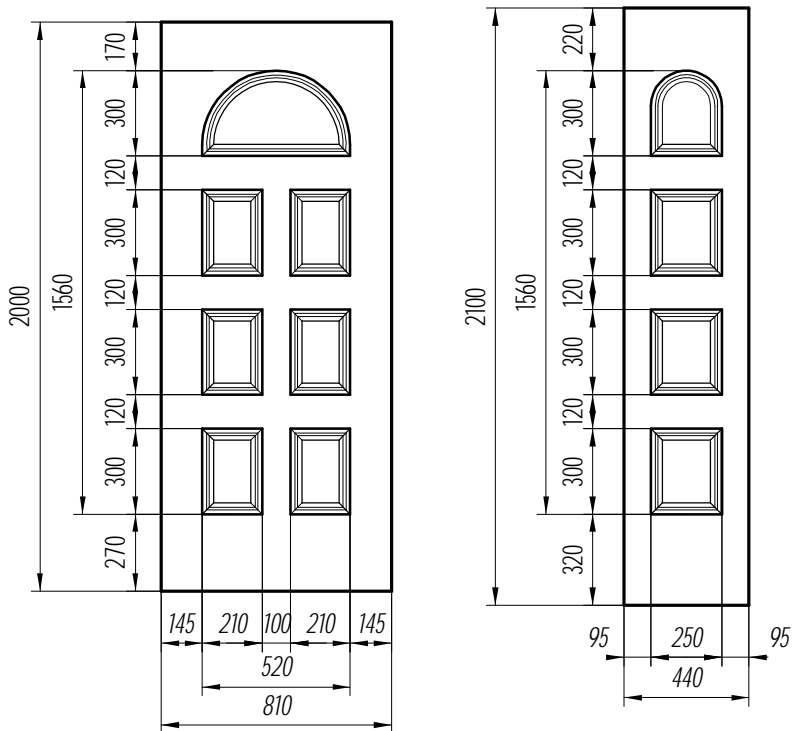

MADRID

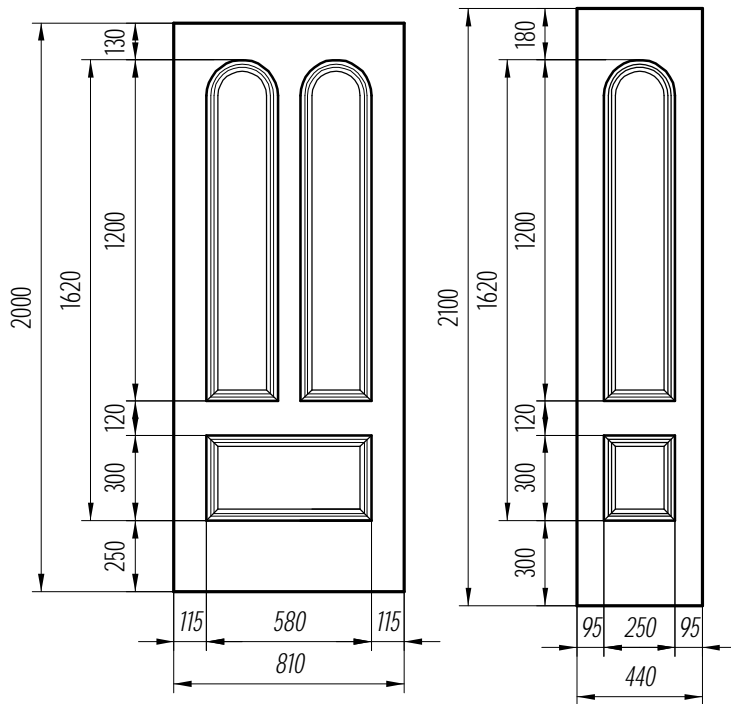

MEXICO

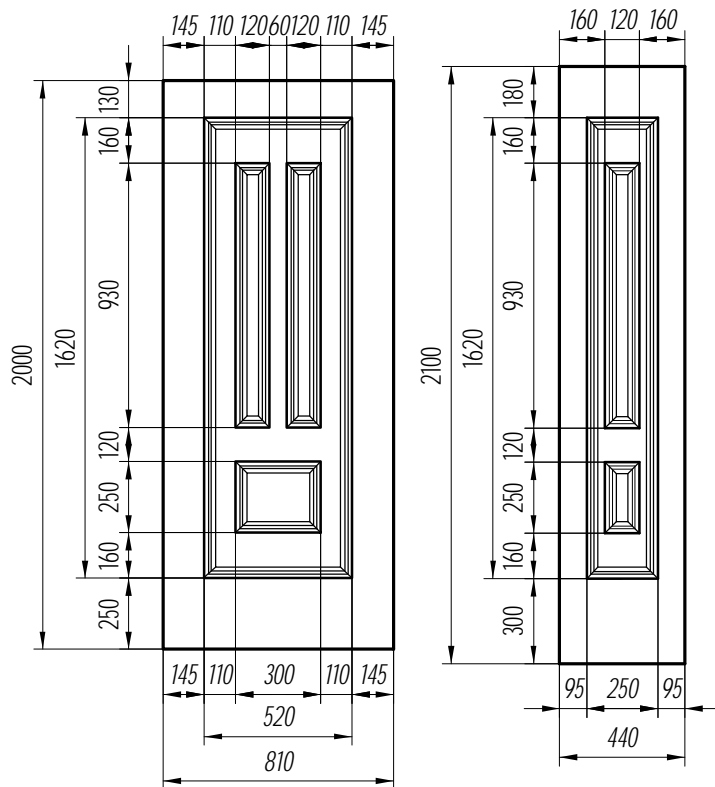

NEW YORK

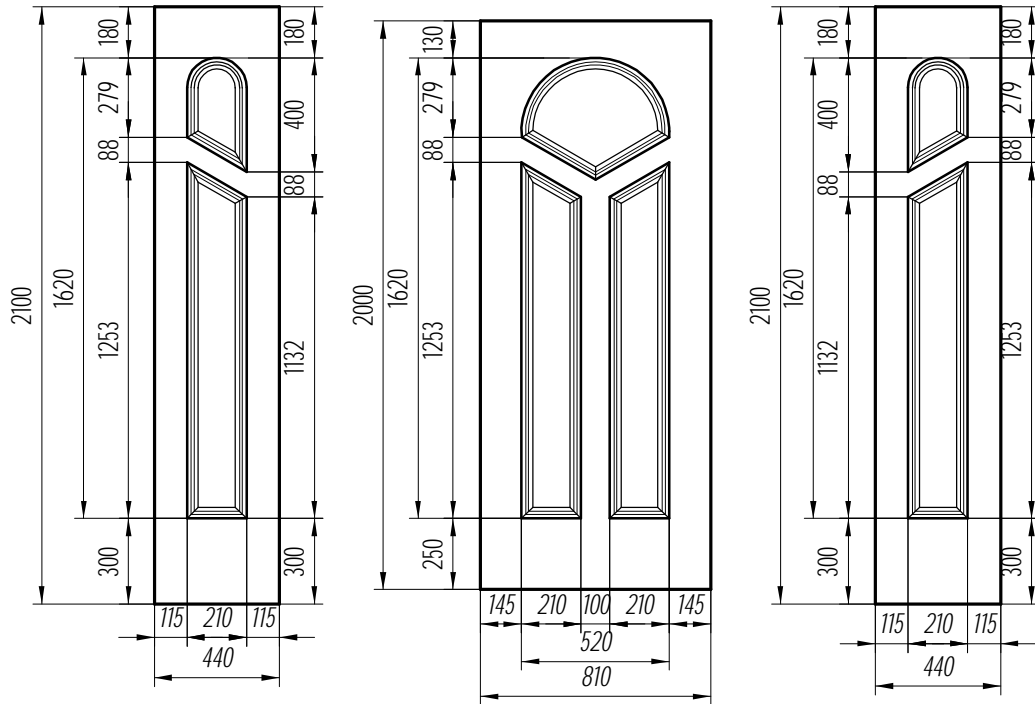

OSLO

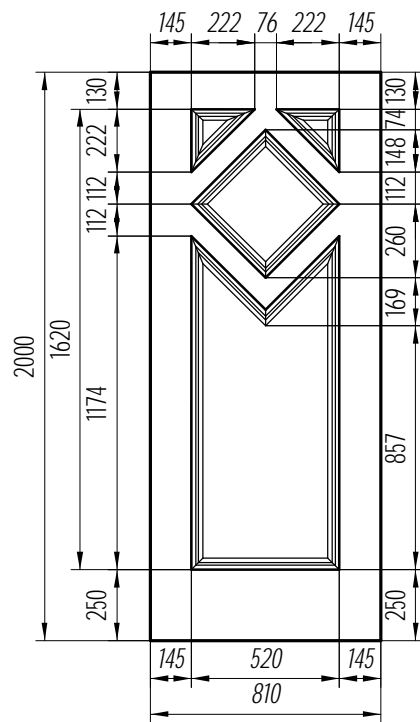

OXFORD

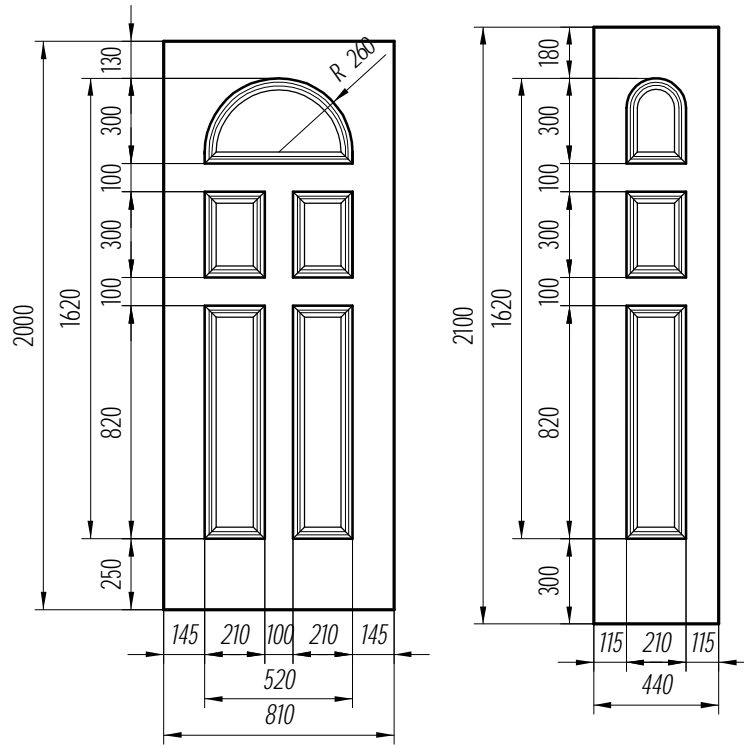

PARIS

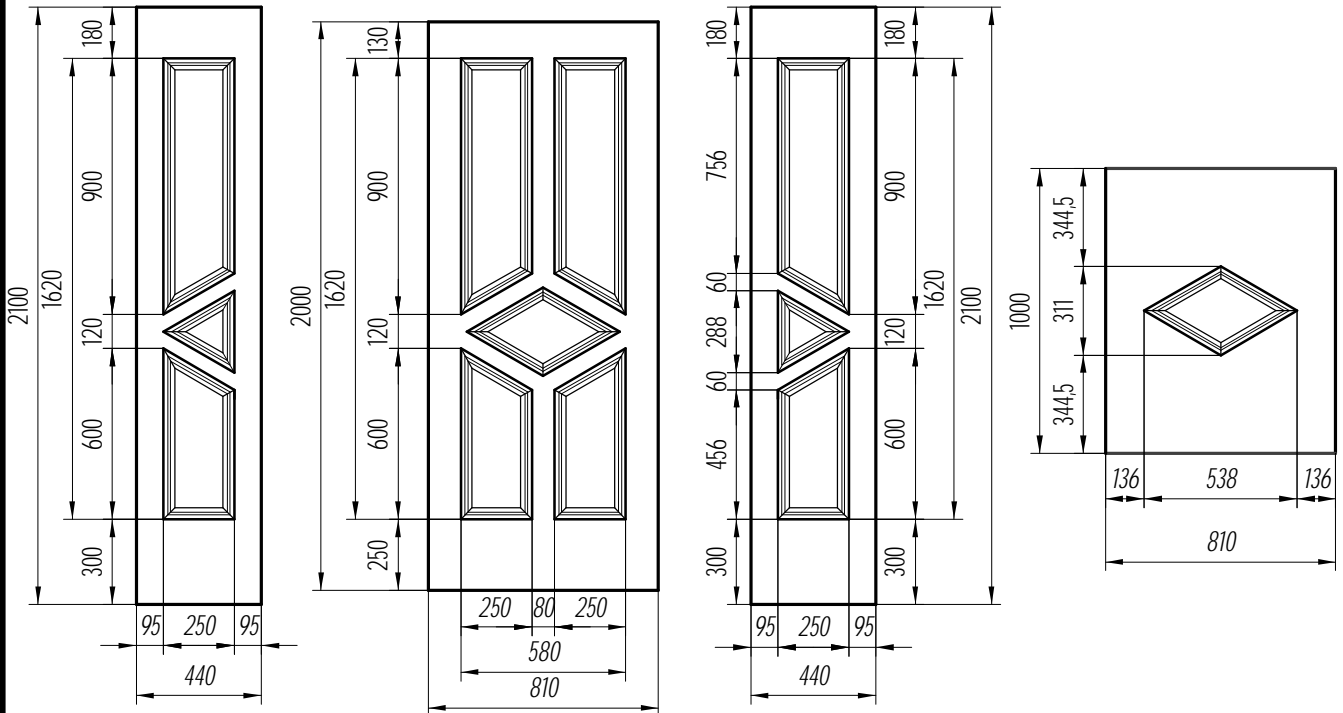

RIO

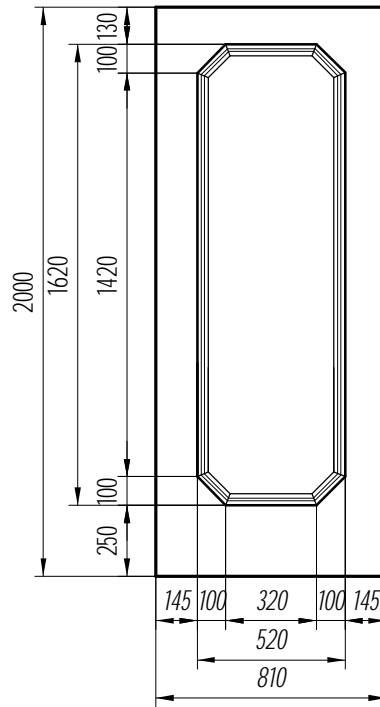

ROMA 2

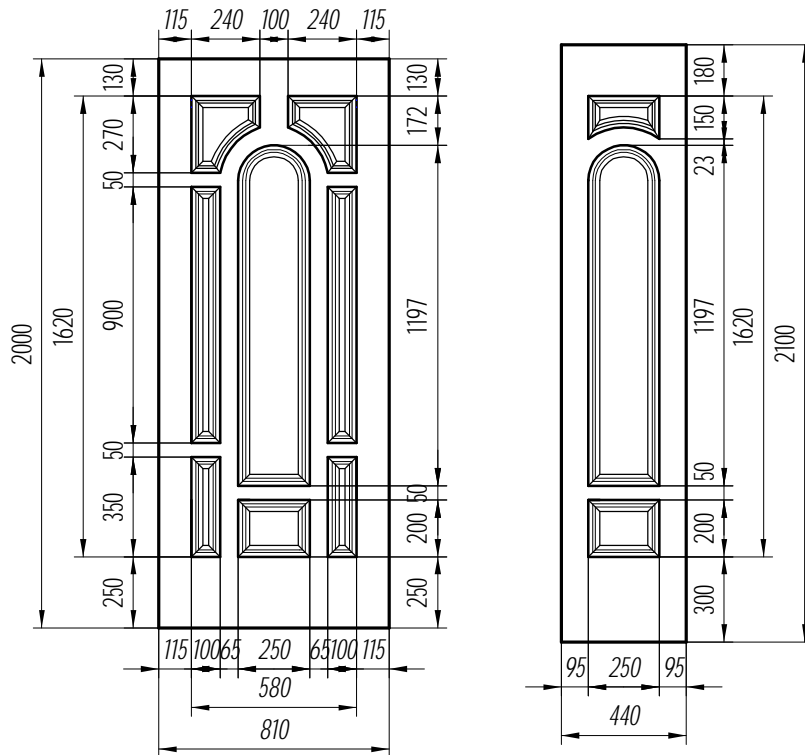

VIENA

